

Str. București Nr. 77
Cluj-Napoca
Tel. Mobil 0746-089697
Tel. Fix/Fax 0264-433929
www.homecons.ro
office@homecons.ro
homecons@yahoo.com
caselemncluj@yahoo.com

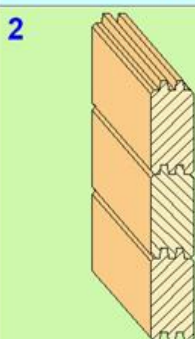

HOMECONS
CASE DIN LEMN

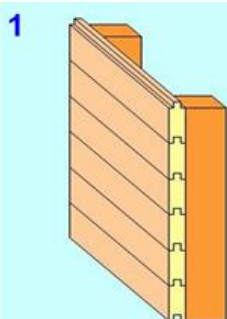

VARIANTA "1" - CASE DE GRADINĂ "1" VARIANT - HOUSES FOR GARDEN

Structura de rezistență grinzi 5 x 5 cm
(Truss 5x5 cm beams)

Lambriu 2 cm cu nut și feder, finisat pe ambele fețe
(2 cm panelling with tongue-and-groove joint,
double side finished)

VARIANTA "2" - CASE DE GRADINĂ "2" VARIANT - HOUSES FOR GARDEN

Bărnă 4.5 cm cu dublu nut și feder.
(4.5 cm beam with double tongue-and-groove joint)
(100-140 EUR/mp)

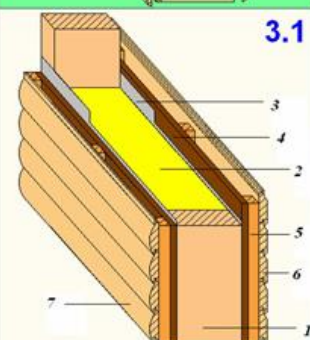
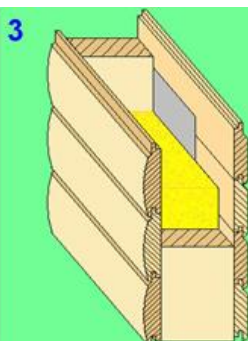

VARIANTA "3 - 3.1" - CASE DE VACANȚĂ "3 - 3.1" VARIANT - HOLIDAY HOUSES

Structura de rezistență grinzi 5 x 10 - 5x15 cm
(truss with 5x10 - 5x15 cm beams)

Pereți tip "sandwich" (Sandwich" type walls)

Lambriu semirotund de exterior 2.2 cm
(2.2 cm exterior half-rounded panelling)

Vată minerală 10-15 cm (10-15 cm mineral wool)

Folie barieră de vapori, OSB, lețuri pentru gol de aer
(Protective folio against steam, OSB)

Lambriu interior de 1.8 cm, sau gipscarton
(1.8 cm inner panelling or plaster cardboard)

(140-180 EUR/mp)

Str. București Nr. 77
Cluj-Napoca
Tel. Mobil 0746-089697
Tel. Fix/Fax 0264-433929
www.homecons.ro
office@homecons.ro
homecons@yahoo.com
caselemncluj@yahoo.com



HOMECONS
CASE DIN LEMN

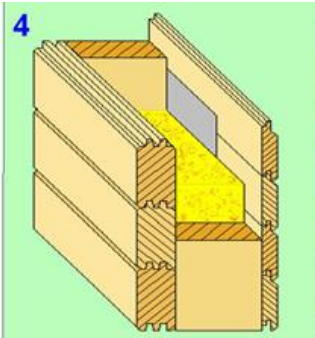

4

4.1

VARIANTA "4 - 4.1" – CASE DE VACANȚĂ
"4 - 4.1" VARIANT – VACATION HOUSES

- Bărnă 4.5 cm cu dublu nut și feder
(4.5 cm beam with double tongue-and-groove joint)
- Folie barieră de vapori
(Protective folio against steam)
- Structura de rezistență grinzi 5 x 10 – 5x15 cm
(truss with 5x10 - 5x15 cm beams)
- Vată minerală 10-15 cm, OSB, lețuri pentru gol de aer
(10-15 cm mineral wool, OSB)
- Lambriu interior de 1.8 cm, sau gipscarton
(1.8 cm inner panelling or plaster cardboard)

(150-185 EUR/mp)

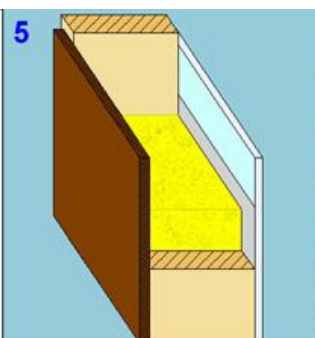

5

5.1

VARIANTA "5 - 5.1" – CASE "AMERICANE"
"5 - 5.1" VARIANT – "AMERICAN" HOUSES

- Structura de rezistență grinzi 5 x 15 cm
(truss with 5x15 cm beams)
- Pereți tip "sandwich" (Sandwich" type walls)
- Placă OSB la exterior-interior (OSB board)
- Vată minerală 15 cm
(15 cm mineral wool)
- Folie barieră de vapori
(Protective folio against steam)
- Lambriu interior de 1.8 cm sau gipscarton.
(1.8 cm inner panelling or plaster cardboard)

(150-185 EUR/mp)

Str. București Nr. 77
Cluj-Napoca
Tel. Mobil 0746-089697
Tel. Fix/Fax 0264-433929
www.homecons.ro
office@homecons.ro
homecons@yahoo.com
caselemncluj@yahoo.com



HOMECONS
CASE DIN LEMN

<p>6</p>	
<p>7</p>	<p>VARIANTA "6" - CASE DE VACANȚĂ "6" VARIANT - HOLIDAY HOUSES</p> <p>Bărnă 7 cm cu dublu nut și feder. (7 cm beam with double tongue-and-groove joint)</p> <p>VARIANTA "7" - CASE DE VACANȚĂ "7" VARIANT - HOLIDAY HOUSES</p> <p>Bărnă 9,5 cm cu dublu nut și feder. (9,5 cm beam with double tongue-and-groove joint) (160-190 EUR/mp)</p>

<p>8</p>	
<p>8.1</p>	<p>VARIANTA "8 - 8.1" - CASE DE LOCUIT "8 - 8.1" VARIANT - DWELLING HOUSES</p> <p>Bărnă 7 cm cu dublu nut și feder (7 cm beam with double tongue-and-groove joint) Grinzi de 5x10 cm (5x10 cm beams) Vată minerală 10 cm (10 cm mineral wool) Folie barieră de vapori, OSB, lețuri pentru gol de aer (Protective folio against steam, OSB) Lambriu interior de 1.8 cm sau gipscarton. (1.8 cm inner panelling or plaster cardboard) (180-205 EUR/mp)</p>

Str. București Nr. 77
Cluj-Napoca
Tel. Mobil 0746-089697
Tel. Fix/Fax 0264-433929
www.homecons.ro
office@homecons.ro
homecons@yahoo.com
caselemncluj@yahoo.com



HOMECONS
CASE DIN LEMN

9

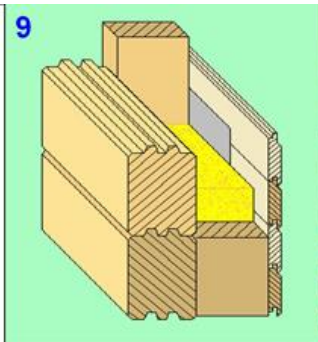



9.1

VARIANTA "9 - 9.1" - CASE DE LOCUIT
"9 - 9.1" VARIANT - DWELLING HOUSES

- Bărnă 9,5 cm cu dublu nut și feder (9,5 cm beam with double tongue-and-groove joint)
- Grinzi de 5x10 cm (5x10 cm beams)
- Vată minerală 10 cm (10 cm mineral wool)
- Folie barieră de vapori, OSB, lețuri pentru gol de aer (Protective folio against steam, OSB)
- Lambriu interior de 1.8 cm sau gipscarton (1.8 cm inner panelling or plaster cardboard)

(180-230 EUR/mp)



10

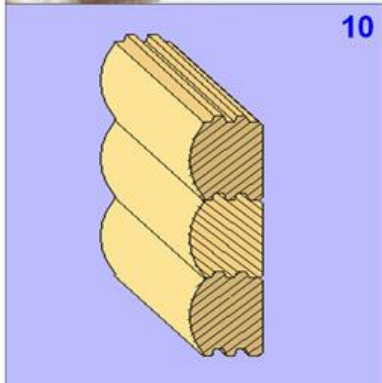

VARIANTA "10" - CASE DE VACANȚĂ
"10" VARIANT - HOLIDAY HOUSES

- Bărnă semirotondă de 9,5 cm cu dublu nut și feder (9,5 cm beam half-rounded with double tongue-and-groove joint)

(170-190 EUR/mp)

Str. București Nr. 77
Cluj-Napoca
Tel. Mobil 0746-089697
Tel. Fix/Fax 0264-433929
www.homecons.ro
office@homecons.ro
homecons@yahoo.com
caselemncluj@yahoo.com



HOMECONS
CASE DIN LEMN

11



11.1

VARIANTA "11-11.1" – CASE DE LOCUIT
"11-11.1" VARIANT - DWELLING HOUSES

Bărnă semirotondă 9,5 cm cu dublu nut și feder
(9,5 cm beam half-rounded with double tongue-and-groove joint)
Grinzi de 5x10 cm
(5x10 cm beams)
Vată minerală 10 cm (10 cm mineral wool)
Folie barieră de vapori, OSB
(Protective folio against steam, OSB)
Lambriu interior de 1.8 cm sau gipscarton.
(1.8 cm inner panelling or plaster cardboard)
(180-230 EUR/mp)

12



12.1

VARIANTA "12-12.1" – CASE DE LOCUIT
"12-12.1" VARIANT - DWELLING HOUSES

Bărnă lamelară 9,5 cm cu dublu nut și feder
(9,5 cm beam half-rounded with double tongue-and-groove joint)
Grinzi de 5x10 cm
(5x10 cm beams)
Vată minerală 10 cm (10 cm mineral wool)
Folie barieră de vapori, OSB
(Protective folio against steam, OSB)
Lambriu interior de 1.8 cm sau gipscarton.
(1.8 cm inner panelling or plaster cardboard)
(210-250 EUR/mp)